

Signal Placement for Model Railroads

Prepared for a Seminar
given for the Pacific Southwest Region of the NMRA

by Barry Draper email barry_draper@hotmail.com
(626) 281-3528

Given their traffic density, most model railroads should have signals. Modelers generally like signals, and most would like to have some on their layout, but one question is where should the signals be placed? Each layout is a separate unique case, but prototype railroads have rules for placing signals that can be applied to find suitable places to put signals on our layouts.

First the type of signals to be installed must be determined. Automatic Block Signals, or ABS are the simplest since these signals only indicate the presence (or absence) of a train in the blocks ahead and require no control by an operator. Interlocking Signals may be called for at a junction and can also be an excuse to model the always popular Interlocking Tower. Most high traffic main lines are now signaled with Centralized Traffic Control, or CTC which allows the dispatcher to control the movement of trains with Controlled Signals at Control Points, or CPs. This is a great way to dispatch trains on a model railroad too, but it will require more complicated electronics to run the signals.

Signaled territory is divided into signal blocks, with signals at the block boundaries governing entrance to the block. The exact rules vary from railroad to railroad, and ABS, CTC, and Interlockings are governed by different rules, but the placement of the block boundaries and the signals is fairly standard. The prototype signal blocks end up being very close to the electrical sections, more commonly called blocks used for control on a model railroad, and it is very convenient to let them be the same on a model railroad. If you are using DCC or another command control system you will need to establish signal blocks and they can match prototype practice.

The first step is to determine how close to the track signals should be placed. The diagram on the next page shows the standards used by three prototype railroads. This can guide you when placing a signal on your layout.

SYSTEM STANDARDS DIMENSIONS FOR THREE RAILROADS

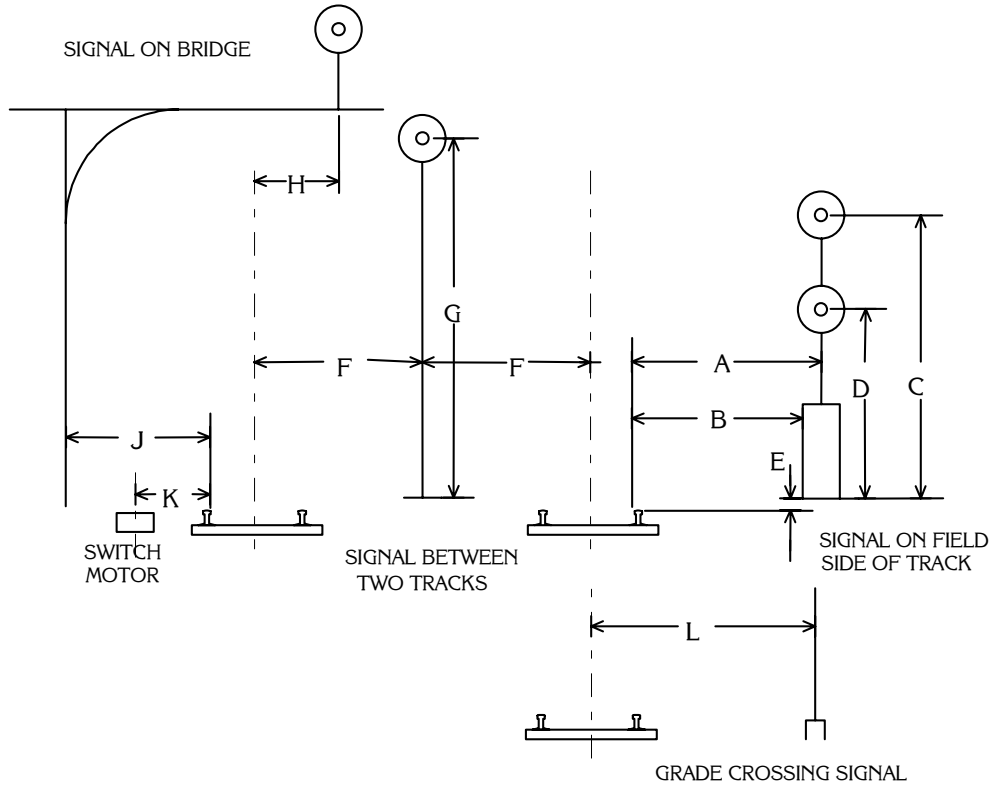

	AT&SF	Southern Pacific	MKT
A	10'-0"	---	10'-5"
B	---	7'-0"	---
C	15'-0"	15'-0"	12'-2" Color Light; 22'-6" Semaphore
D*	10'-0"	10'-0"	---
E	8"	0"	0"
F	9'-0"	9'-6"	---
G	19'-0"	18'-0"	---
H	4'-6"	5'-6"	---
J	7'-9"	---	----
K	4'-0"	---	----
L	15' to Flasher, 12' to Gates	----	---

*Dimension "D" is only used for two head signals; use dimension "C" for single head signals.

NOTE: System standards are always subject to change to meet the needs of each installation; they are only a guide used by the Railroad's signal engineers when designing each installation.

INTERMEDIATE SIGNALS

Intermediate Signals are the “normal” block signals between sidings, interlockings and control points. Most signals on prototype railroads are intermediate signals because of the long distances covered, but most model railroads could be signaled with no intermediate signals at all. Intermediate signals are usually found as a pair, one for each direction of traffic. The length of a block varies from 3000' on installations dating from the 1920s to over two miles on some modern installations. Length of a block is determined by several factors: The limit of how far a track circuit can be made reliable; the stopping distance of a train at track speed; and the geography, such as bridges, tunnels, etc. If blocks are shorter than the stopping distance of a train, then the signals must give an Advance Approach indication (some railroads use Approach Medium) to give the engineer enough distance to stop the train. Of course, the length of a block on a model railroad is determined more by the space available.

Intermediate Signals will normally have a number plate attached because they are not absolute stop signals. A train may pass an intermediate signal at stop after stopping. The number on the plate is the milepost that the signal is in plus one digit at the end. This digit will be even for Eastward signals and odd for Westward. On some railroads the last digit is the approximate tenth of a mile, and others simply number starting with 1 & 2 in each mile, but the odd/even rule holds in any case.

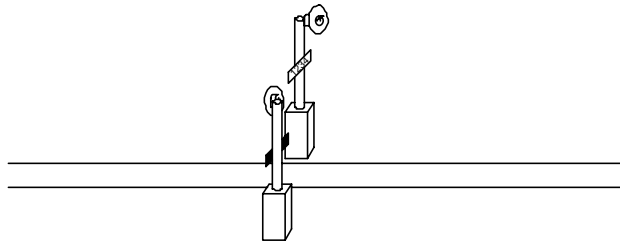

Intermediate Signals on Single Track

While there will normally be a signal for both directions at each block boundary, some systems, such as Overlap Block Signaling, result in the East and West Signals being separated. Such cases are rare, however.

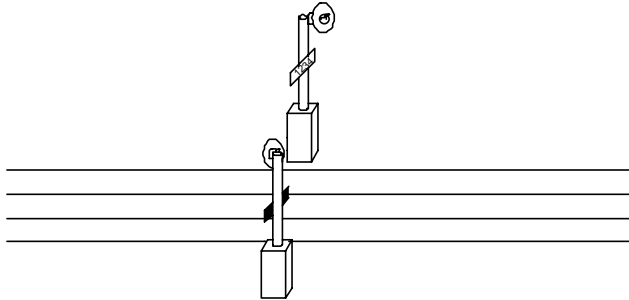

Intermediate Signals on Double Track

Double track with each track signaled for one direction of traffic will still usually have the signals for both directions opposite each other. If other conditions such as a bridge or curve location dictate that the East and West signals be at different locations this will be done, since the blocks on each track are separate, and signals do not need to be at the same location.

Automatic Block Signals at Sidings

A siding is a place named in the Timetable, and is intended for the meeting of trains. Industrial tracks that exist only to serve rail customers generally don't get special signal treatment; the intermediate block signals are simply placed where normal spacing causes them to fall. Of course there may be industrial tracks at the location of a siding. Sidings will have signals at each end, just clear of the switch, as shown below. In Automatic Block Signal territory all switches are hand thrown and signals do not directly indicate the position of switches. If a mainline switch is open, the signals facing into that block will be at stop. (This is true of any mainline switch.) If a train is to enter a siding, the engineer will stop, a member of the train crew will line the switch, which will put the signal at stop, and the engineer will then pass the signal at stop and enter the siding.

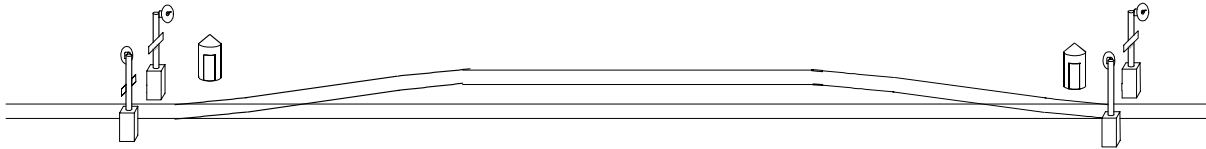

In ABS territory all signals have number boards and may be passed at restricted speed when at stop.

In Absolute/Permissive territory the signals leaving each siding do not have number boards and are Absolute signals that may only be passed with the dispatcher's permission when at stop.

In pre-radio days most sidings lacking a station had a dispatcher's phone booth located near each end so trains could contact the dispatcher if necessary. Beginning in the 1960s these were removed as radio made them unnecessary. Absolute/Permissive signaling is wired so that all opposing signals to the next siding drop to stop in front of a train. The theory is that an opposing train will thus be held at a siding. Although Absolute/Permissive signaling is common in ABS territory, most railroads do not use it as a method of dispatching trains.

CTC signals at sidings

CTC sidings have a common placement of signals at each end as shown below. The area around the switch protected by the signals is called a Control Point or CP (some railroads used to call this an OS section). None of the signals at a CP have number plates as all are Absolute signals controlled by the dispatcher. The Switches are also controlled by the dispatcher. Some railroads used to put a plate with an "A" on the signals to signify that they were Absolute, but this practice was dropped in the 1980s. There is usually a CTC shed at each CP to house equipment, and recent installations may have a radio or microwave tower for the link to the dispatcher.

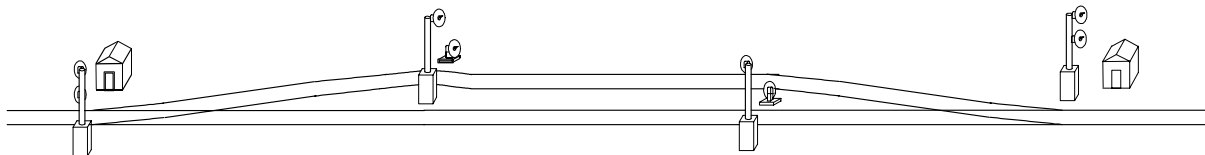

Typical CTC siding

The signals leaving the siding are placed at the clearance point so a train stopped at the signal will not foul the other track. Dwarf signals are often used for the siding, but high signals may be the standard in some territories. The signals entering the siding will usually be at the switch points, but may be located a distance down the single track for reasons of visibility by the engineer of an approaching train. Signals entering the siding will usually (but not always) be a two head signal. For simplicity, modelers can consider the top head to signal for the main and the bottom for the siding, although this is not always the way signal rules state.

INTERLOCKINGS

An Interlocking is a section of track over which movement of trains is governed by signals which are controlled by the Interlocking Operator. Interlockings are normally located at important junctions, where railroads cross at grade, and at the approach to major passenger terminals. Some Eastern railroads used a series of Interlockings to dispatch trains on multiple track territory. Each and every track entering the interlocking limits will have an Absolute signal governing the movement of trains. The operator controlling the signals and switches at an Interlocking was usually located in a tower placed so he had good visibility of all tracks approaching his interlocking. These are the classic "Towers" so often modeled and seen on so many model railroads.

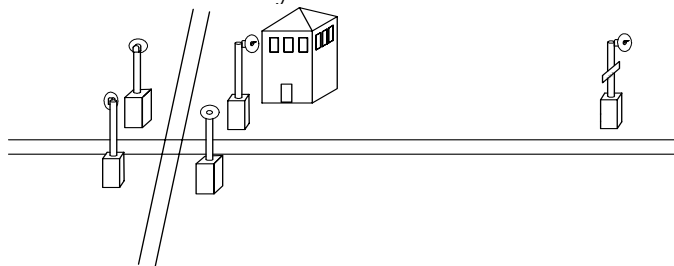

Interlocking at a Crossing

If the Interlocking is in ABS territory the next Intermediate signal will serve as an Approach signal, but if the track is unsignaled (Dark) then an Approach signal will be located about 1000' from the Home signal in each direction as shown at the right.

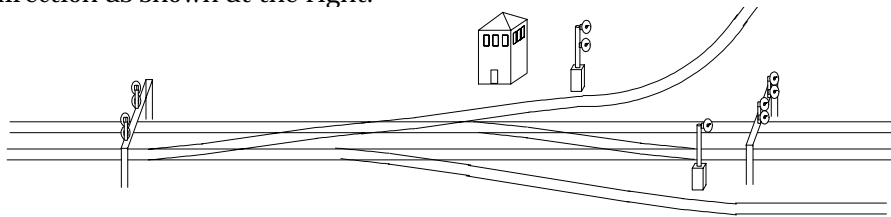

Signal Placement at a Junction

Signal placement is designed for each unique Interlocking, so this is just one example. For modeling purposes we can again assume that the top signal head governs the Main track, and the lower head governs the Diverging route, although this is a simplification and does not take into account three head signals, which were not used by all railroads. At some large complex Interlockings there may also be additional home signals located in the plant, but only advanced signal modelers need concern themselves.

In 1950 there were Interlocking Towers all over the country, but almost all are gone now. Some at RR crossings have been automated, but most were incorporated into CTC as railroads expanded the miles of track so controlled. In the last few years most remaining Towers have been converted to remote operation by the dispatcher, even if full CTC was not installed.

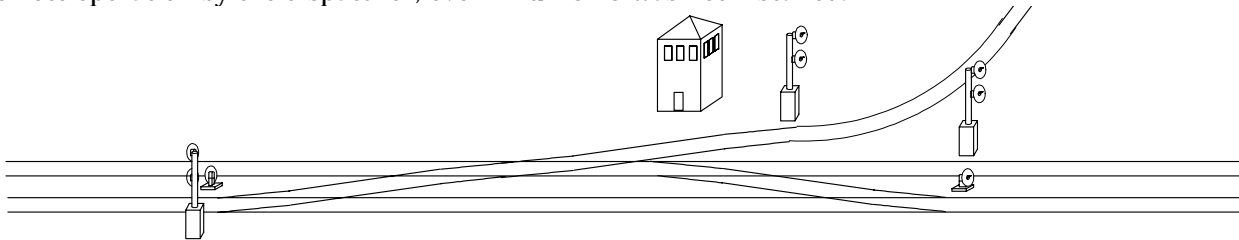

Double Track Showing Use of Dwarfs

In some cases Dwarf signals will be used so signal bridges are not necessary. This example is double track with each track signaled for one direction. Note that a signal is still required on every track entering the Interlocking.

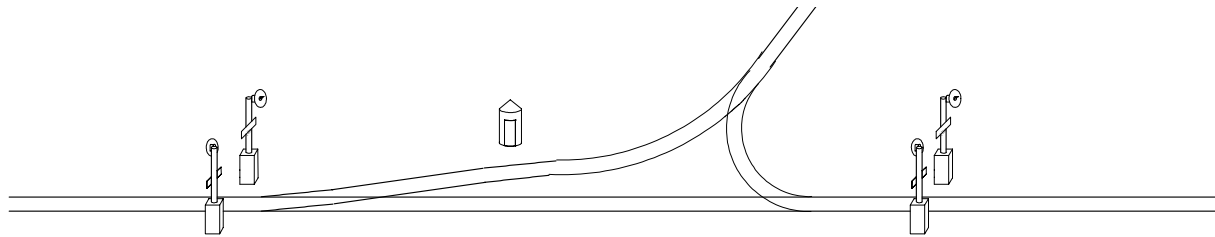

ABS Junction

While Interlockings were used at major junctions, if the railroad did not feel the expense of staffing an Interlocking Tower was justified a junction in ABS territory would be left with hand throw switches. Here the signals work much like ABS at a siding, with a simple stop indication if a switch is lined for the branch. Thus, it is not necessary to have special signaling at a junction if you wish to avoid the trouble. Please note, however, that any junction in CTC territory, no matter how minor, would have a Control Point with full controlled signaling. The signal placement would be as shown for an Interlocking, but without the tower and remotely controlled by the dispatcher.

Field Side Signals

American railroad standards called for signals to be placed on the right hand side of the track (the exception to this was the Chicago & North Western which used left hand running and signals). This was because the Engineer of a steam engine could only see the right hand side of the track. The same was true for first generation hood diesels. For single track or double track signaled for right hand running only this was easy enough, but for multiple track a signal bridge was required. When a signal bridge is used the signal for each track is 4' to 6' to the right of the center line of the track it governs. On double track where signaling for left hand running or both tracks in both directions was required this meant that expensive signal bridges must be built. The Santa Fe had dozens in Arizona and New Mexico.

Starting in the 1980s railroads changed their rules to allow Field Side signals. This was first done on double track with the signal governing the right hand track to the right and the signal governing the left hand track to the left. If there are three or more tracks a signal bridge is still used, with each signal placed as always to the right of its track. Railroads are now applying the principle of field side signaling to single track with new installations having a single mast with signal heads facing in both directions. There is no rule regarding whether such signals are on the north or south side of the track.

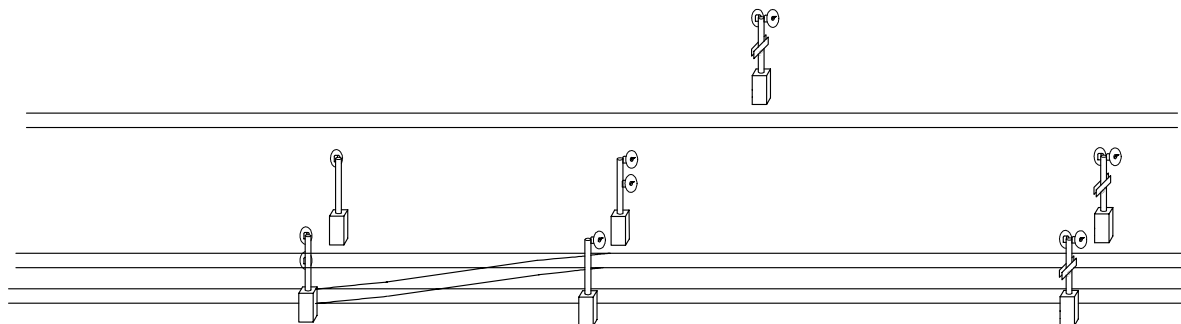

Field Side Signals on Single and Double Track

Bracket Signals

Some railroads have, in the past, avoided a full signal bridge in multiple track territory by the use of bracket signals. Bracket signals are placed to one side on the track and will have a mast for each track present. If a track is not signaled the mast for that track will have what is called a Doll Signal, which is a blue light with no target. This is merely a place holder and is not to be confused with a blue flag, which would mean a track out of service.

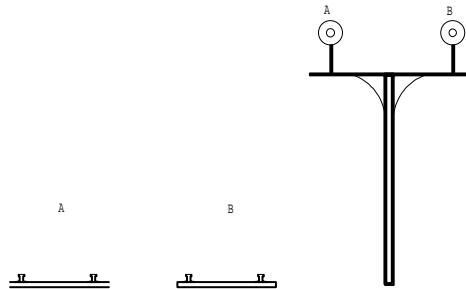

Example of Two Track Bracket Signal

Bracket signals are always on a high mast because both signals must be visible to the engineer of a train on the far track, even if a train is passing on the other track, and remember this means the engineer of a steam engine. Bracket signals were only used by a very few railroads, and then only in certain territories.

Signals at Yards

Signaling at yards does not need to be complicated. Only the largest classification yards have an interlocking plant controlling access to the yard; most yards, even division point yards, have hand throw switches connecting them to the main or a controlled siding. There are of course exceptions, but most yards have no signals in the yard itself; signals are only on the main tracks. Many yards do have switch indicators which are low signals placed right at each switch that only indicate which way the switch is thrown. These replace switch lanterns and are much smaller than a dwarf block signal.

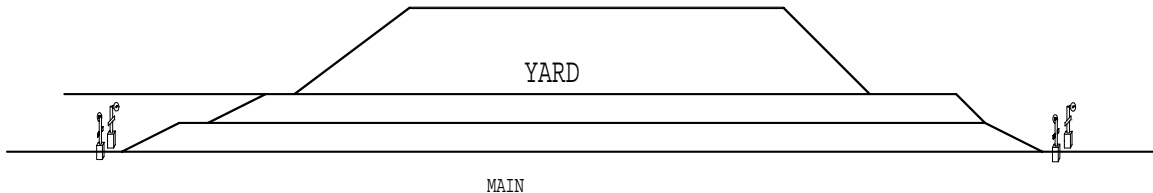

Yard in ABS Territory

In ABS territory most yards are treated like a siding, with all switches being hand throws. There will be Yard Limits on the main, but that only affects the right to use the main track, not the placement of signals.

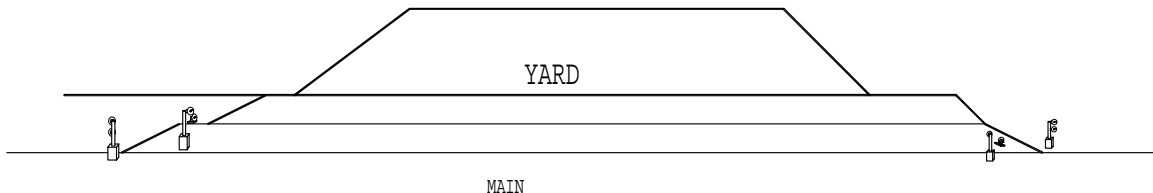

Yard in CTC Territory

A yard in CTC territory is also signaled like a siding. The "siding" track is used as an inbound/outbound lead for the yard. The timetable will state that CTC rules are not in effect on the siding, so the hand throw switches that access the yard do not need switch locks or signals.

Special ABS Signals

While CTC signals are all placed pretty much the same there were some variations used in ABS signals. They don't need to be used in modeling, but you may come across them when railfanning the prototype.

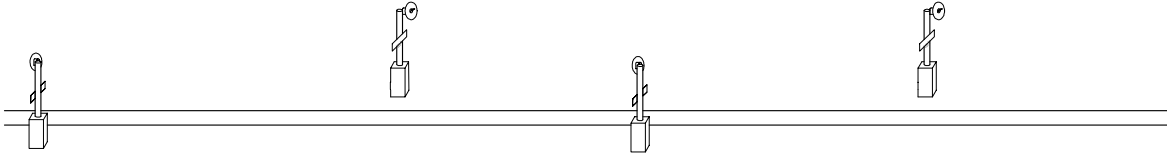

Overlap Block Signaling

Overlap signaling is ABS but the signals alternate in the direction they face. This was used primarily on low density or high speed territory, and mostly to reduce to cost of installing signals.

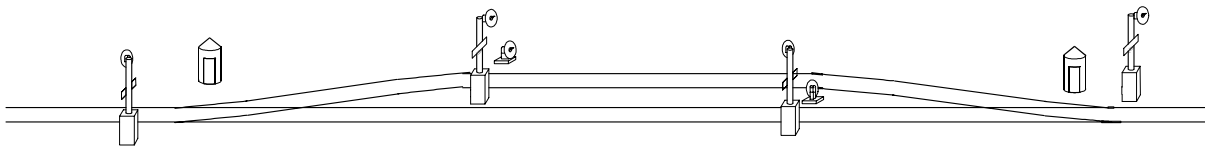

ABS Spring Switch Siding

This arrangement is very popular with prototype railroads in ABS territory. The switches at both ends of the siding are spring switches, and a train can make a trailing movement out of the siding with the switch lined for the main. This greatly speeds a meet since the inferior train doesn't need to stop to line the switch back, which is even more valuable now that cabooses are a thing of the past. At first glance the signaling looks like CTC, but the switches are spring hand throw, and the signals are not under the dispatcher's control. The figure shows ABS with number plates on all mainline signals; if the territory was Absolute-Permissive Block signals the number plates would be absent from the signals leaving the siding.

Signal Types

All of the figures show searchlight signal heads for simplicity, but any type of signal head can be used depending on the railroad being modeled and the era. I'm making no attempt to cover the kinds of signals used or the aspects and indications; the best source is photographs and the Employee Rule Book and Timetables for the line in question. Regardless of the type of signal used, the placement of the signals will normally follow the same rules.